

Комод Svartvitt высокий распашной

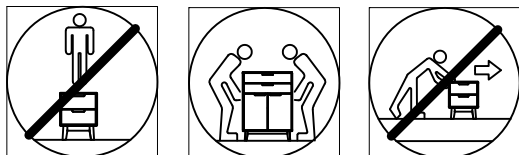

Райтон

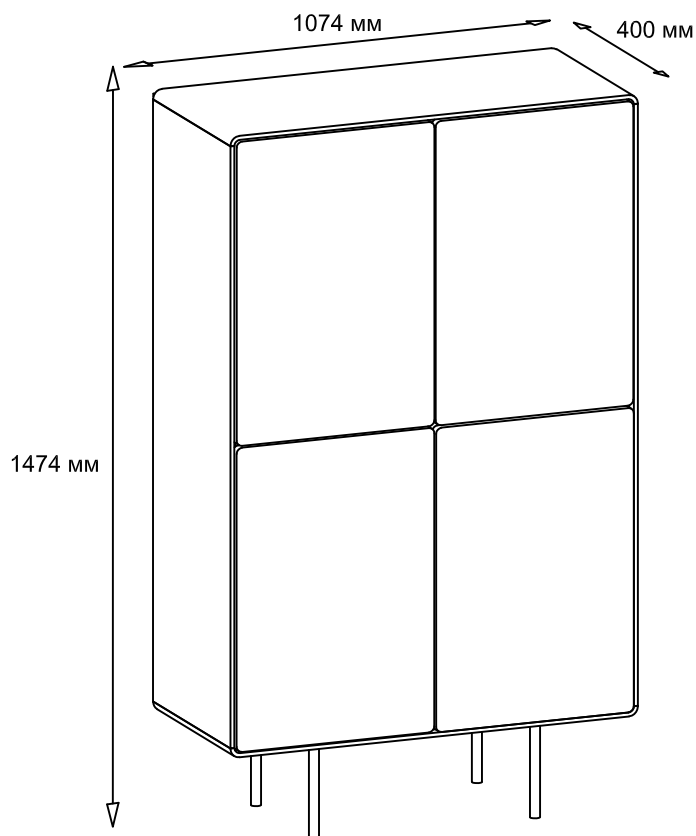

- | | |
|----------------------------------|------------------------------|
| (D) Montageanleitung | (GB) Assembly instructions |
| (FR) Notice de montage | (IT) Istruzioni di montaggio |
| (NL) Handleiding voor de montage | (PL) Instrukcja montażu |
| (CZ) Montážní návod | (SK) Návod na montáž |
| (HU) Szerelési útmutató | (RO) Instrucțiuni de montaj |
| (TR) Montaj talimatları | |

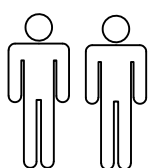

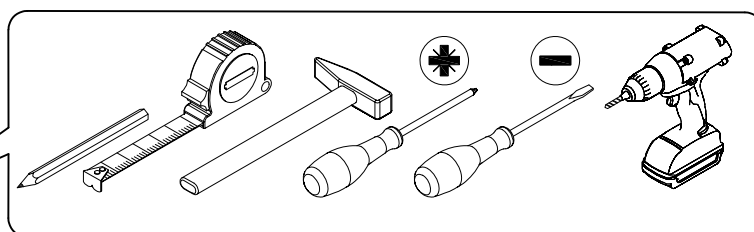
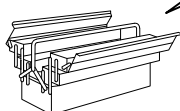

20 min

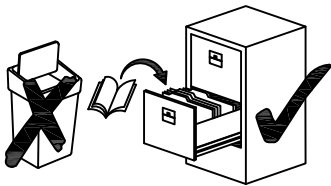

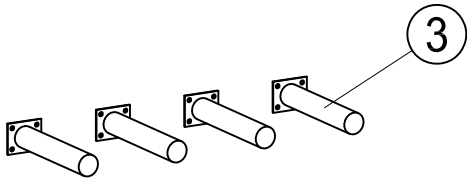
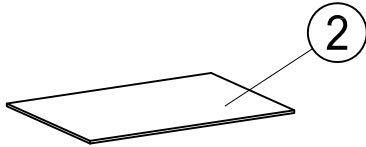
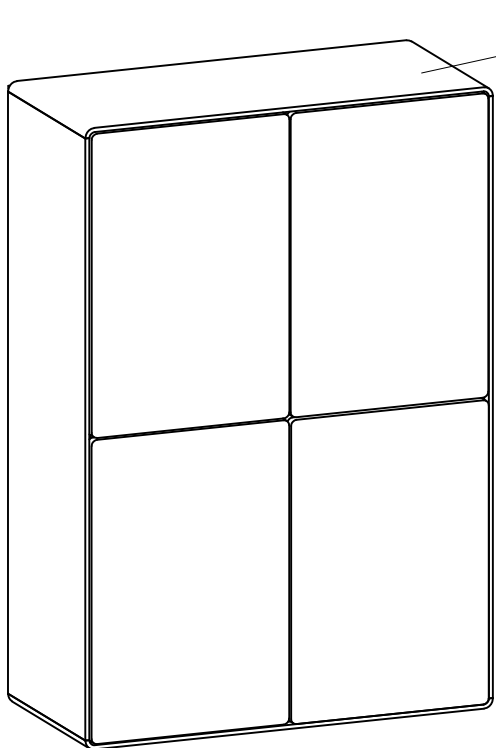
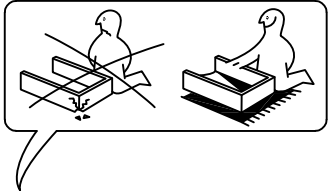
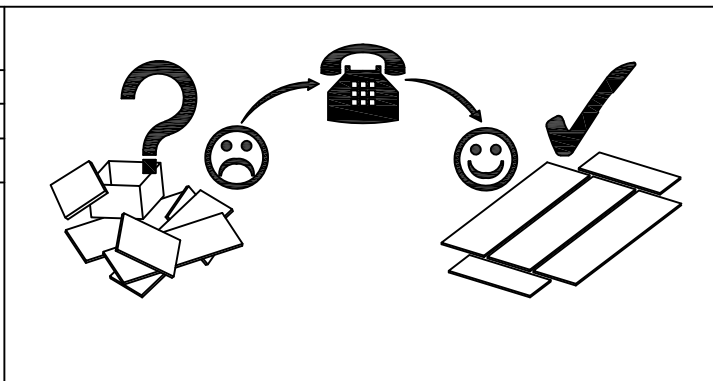
Name • Nom • Nome • Naam • Nazwa • Jaméno • Názov • Név • Denumire • Isim
Nr. • No. • N°
Typ • Type • Tip • Típus • Tipo



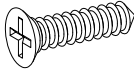
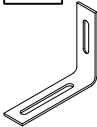
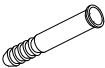

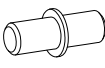

Nº	Size/MaB	Qty	✓
1	1474x400x1074	1	
2	505x358x20	4	
3	200x60x50	4	

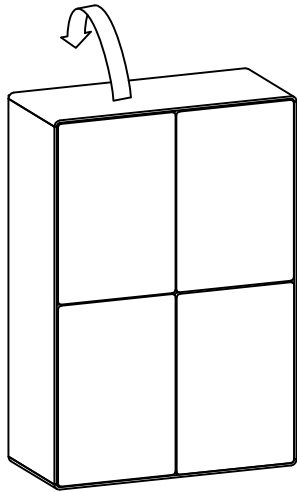
J2 x20  4x16	P1 x2 	G1 x2 	V1 x2 	R1 x4 	Z2 x16 
---	--	--	--	---	---

1

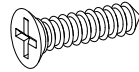

J2 x16	R1 x4
	
4x16	

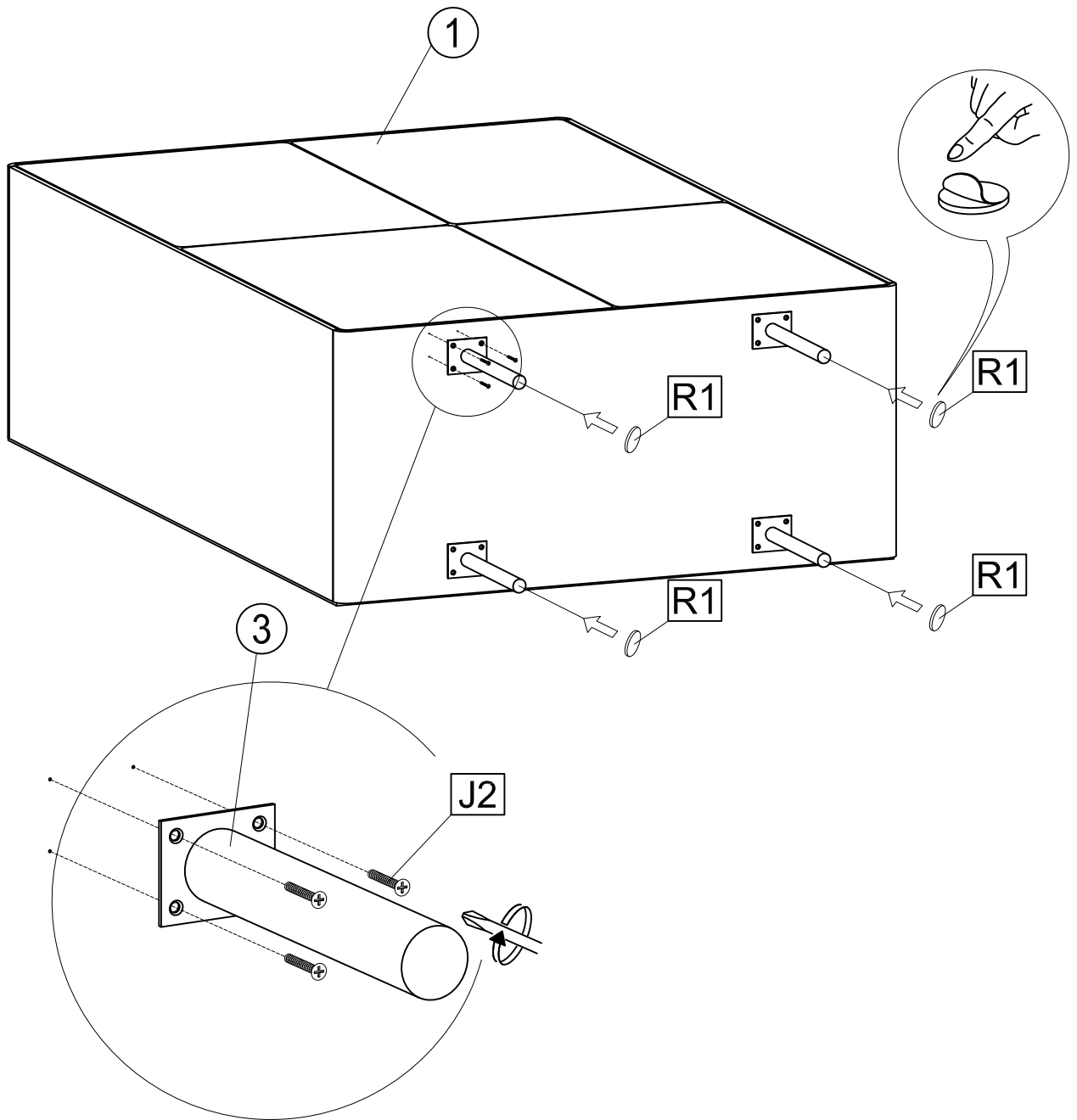

2

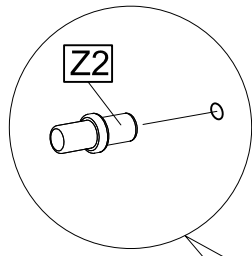

Z2 x16

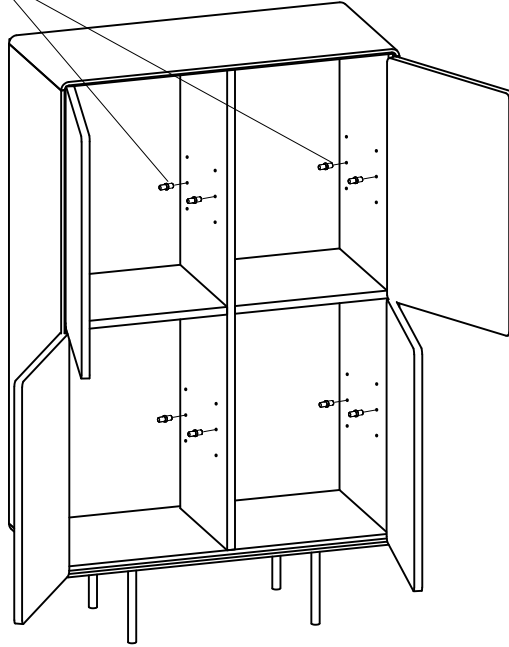
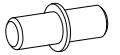

3

3

3

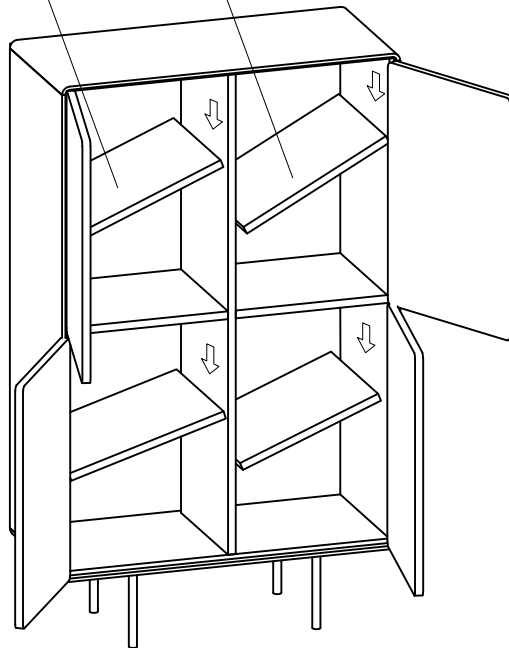

4

J2 x4

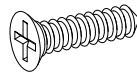

4x16

P1 x2

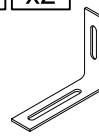

G1 x2

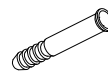

V1 x2

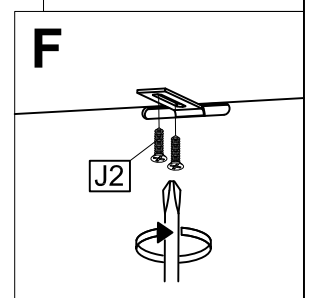
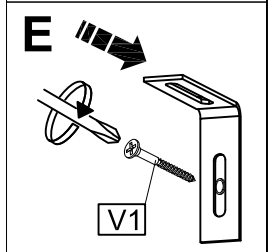
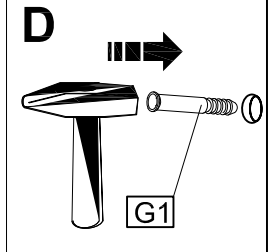
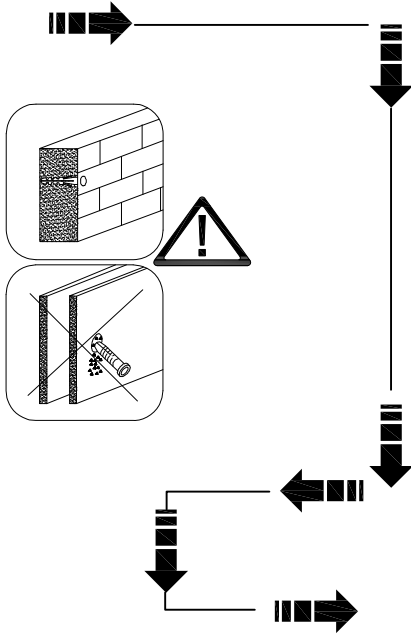
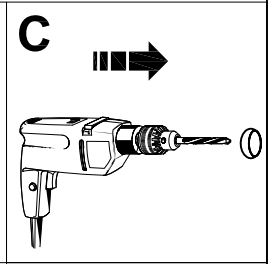
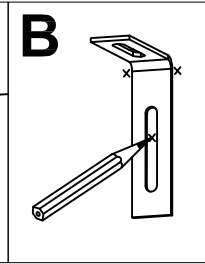
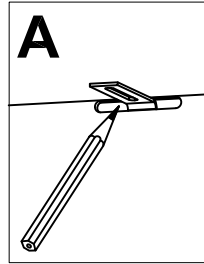
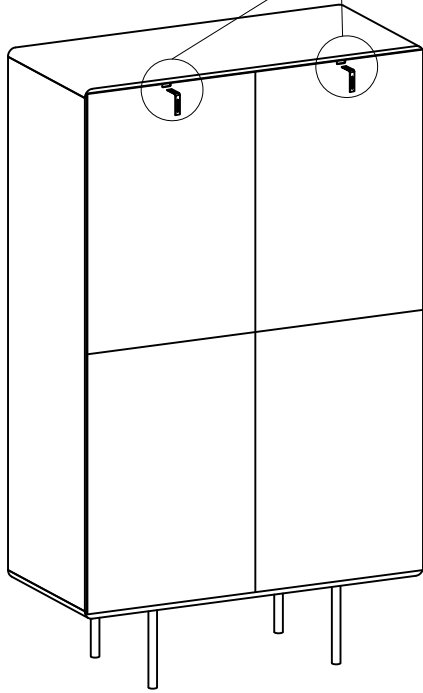
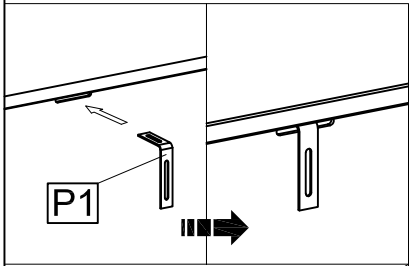

A

A

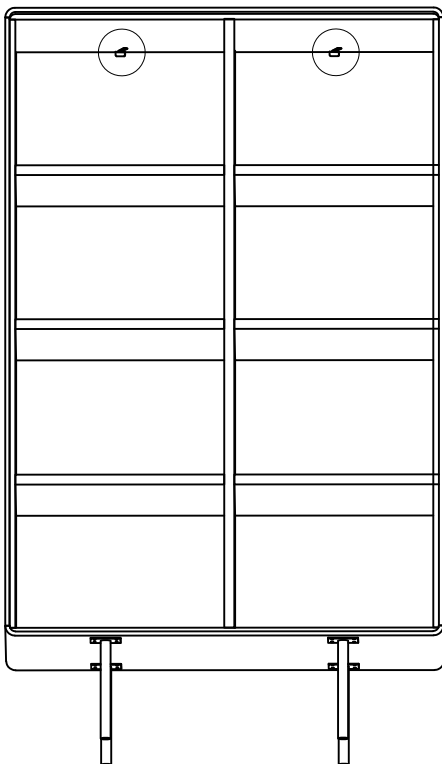

F

F

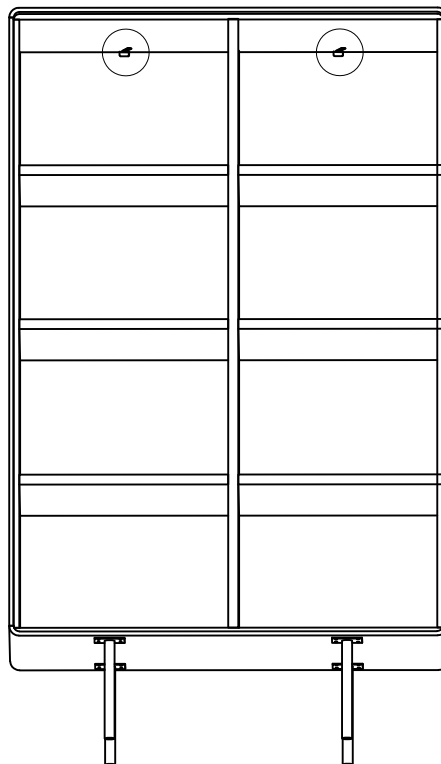

5

